

# ORBIT 2

DUS708 White DUS510 Black

Project: Type:

Cat. No.:

**LED Surface wall luminaire. indirect omnidirectional sconce. Driver included.**

**FIXTURE:**

**Mounting:** surface wall  
**Finish:** White, Black ("powder coat")  
**Material:** Aluminum, acrylic glass  
 Damp Location Listed (for use indoors)  
**CSA/US Listed**

**LAMP/LED SOURCE/COLOR TEMP:**

**-927**  
 7.5W LED / 2700K / CRI ≥ 90 / 660lm  
 Efficacy (CRI ≥ 90): 88lm/W, Rated life > 50000hrs

**DRIVER:**

**-120V/277V-DRV**  
 Class 2 120V-277Vac/60Hz not dimmable,  
 Power factor ≥ 0.9 / Flicker (THD) ≤ 20%, Constant current 350mA  
**-120V-DIM**  
 Class 2 120Vac/60Hz, TRIAC/ELV dimmable (leading/trailing edge),  
 Power factor ≥ 0.9 / Flicker (THD) ≤ 20%, Constant current 350mA

photometric files, dimming compatibility list and warranty information available online at [www.dslightingus.com](http://www.dslightingus.com)

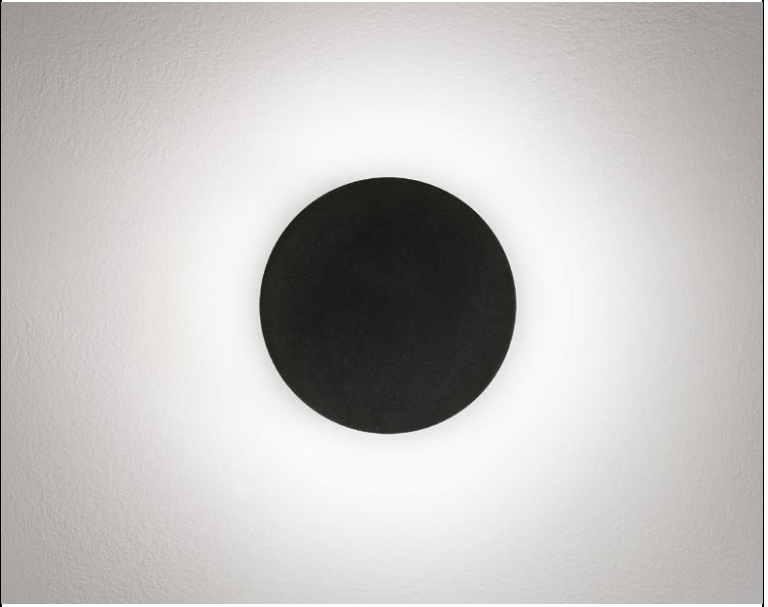

Shown above: DUS510-black-7.5W-927-120V/277-DRV

## Measurements (Inches)

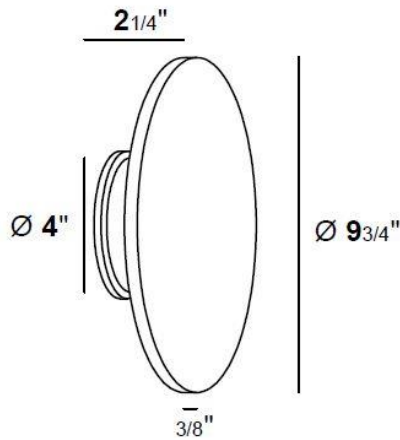

## Light Distribution

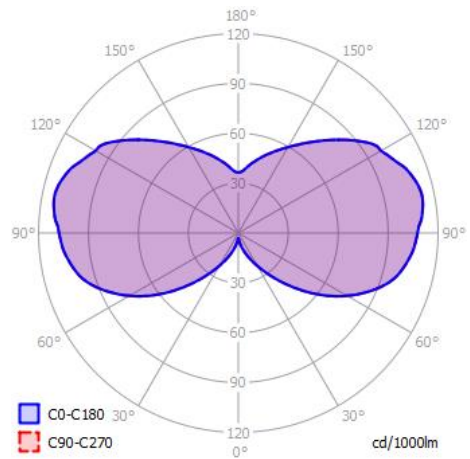

### ORDERING INFORMATION

### -SUFFIX

Model Number	Finish	LED Source	Color Temp.	Driver	
DUS708	-white	-7.5W	-927	-120V/277V-DRV	-120V-DIM
DUS510	-black				
-	-				
-	-				

Example of Catalog #: DUS708-white-7.5W-927-120V-DIM

DLS Lighting US  
 3135 SR 580, Suite 6  
 Safety Harbor, FL 34695  
[www.dslightingus.com](http://www.dslightingus.com)  
[dlsus@dslightingus.com](mailto:dlsus@dslightingus.com)



# ORBIT 3

DUS709 White DUS512 Black

Project:

Type:

Cat. No.:

LED Surface wall luminaire. indirect omnidirectional sconce. Driver included.

**FIXTURE:**

**Mounting:** surface wall  
**Finish:** White, Black ("powder coat")  
**Material:** Aluminum, acrylic glass  
 Damp Location Listed (for use indoors)  
**CSA/US Listed**

**LAMP/LED SOURCE/COLOR TEMP:**

**-927**  
 7.5W LED / 2700K / CRI ≥ 90 / 660lm  
 Efficacy (CRI ≥ 90): 88lm/W, Rated life > 50000hrs

**DRIVER:**

**-120V/277V-DRV**  
 Class 2 120V-277Vac/60Hz not dimmable,  
 Power factor ≥ 0.9 / Flicker (THD) ≤ 20%, Constant current 350mA  
**-120V-DIM**  
 Class 2 120Vac/60Hz, TRIAC/ELV dimmable (leading/trailing edge),  
 Power factor ≥ 0.9 / Flicker (THD) ≤ 20%, Constant current 350mA

photometric files, dimming compatibility list and warranty information available online at [www.dslightingus.com](http://www.dslightingus.com)



Shown above: DUS512-black-7.5W-927-120V/277-DRV

## Measurements (Inches)

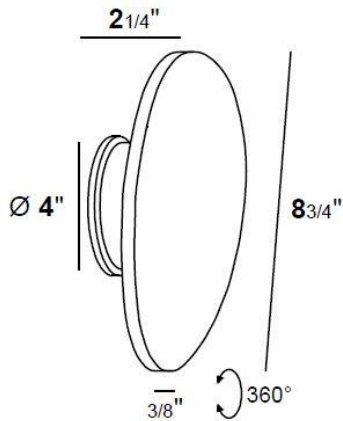

## Light Distribution

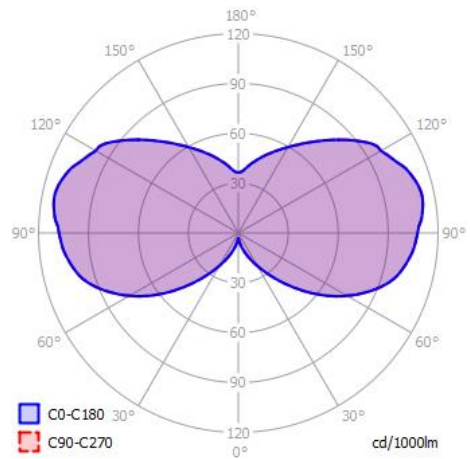

## ORDERING INFORMATION

## -SUFFIX

Model Number	Finish	LED Source	Color Temp.	Driver	
DUS709	-white	-7.5W	-927	-120V/277V-DRV	-120V-DIM
DUS512	-black				
-	-				
-	-				

Example of Catalog #: DUS709-white-7.5W-927-120V-DIM

DLS Lighting US  
 3135 SR 580, Suite 6  
 Safety Harbor, FL 34695  
[www.dslightingus.com](http://www.dslightingus.com)  
[dlsus@dslightingus.com](mailto:dlsus@dslightingus.com)



# ORBIT 4

DUS710 White DUS514 Black

Project:

Type:

Cat. No.:

LED Surface wall luminaire. indirect omnidirectional sconce. Driver included.

**FIXTURE:**

**Mounting:** surface wall  
**Finish:** White, Black ("powder coat")  
**Material:** Aluminum, acrylic glass  
 Damp Location Listed (for use indoors)  
**CSA/US Listed**

**LAMP/LED SOURCE/COLOR TEMP:**

**-927**  
 7.5W LED / 2700K / CRI ≥ 90 / 660lm  
 Efficacy (CRI ≥ 90): 88lm/W, Rated life > 50000hrs

**DRIVER:**

**-120V/277V-DRV**  
 Class 2 120V-277Vac/60Hz not dimmable,  
 Power factor ≥ 0.9 / Flicker (THD) ≤ 20%, Constant current 350mA  
**-120V-DIM**  
 Class 2 120Vac/60Hz, TRIAC/ELV dimmable (leading/trailing edge),  
 Power factor ≥ 0.9 / Flicker (THD) ≤ 20%, Constant current 350mA

photometric files, dimming compatibility list and warranty information available online at [www.dslightingus.com](http://www.dslightingus.com)



Shown above: DUS514-black-7.5W-927-120V/277-DRV

## Measurements (Inches)

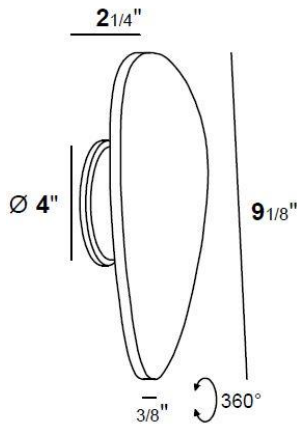

## Light Distribution

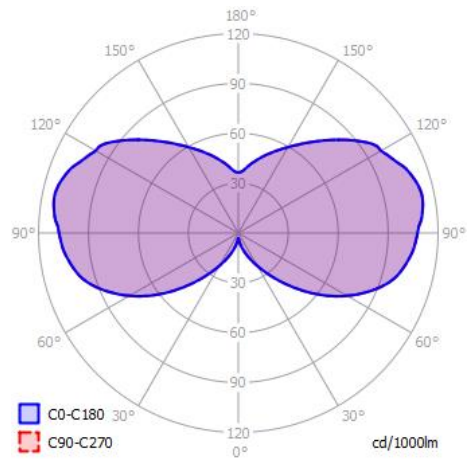

## ORDERING INFORMATION

## -SUFFIX

Model Number	Finish	LED Source	Color Temp.	Driver	
DUS710	-white	-7.5W	-927	-120V/277V-DRV	-120V-DIM
DUS514	-black				
-	-				
-	-				

Example of Catalog #: DUS710-white-7.5W-927-120V-DIM

DLS Lighting US  
 3135 SR 580, Suite 6  
 Safety Harbor, FL 34695  
[www.dslightingus.com](http://www.dslightingus.com)  
[dlsus@dslightingus.com](mailto:dlsus@dslightingus.com)

